

Detalle de Tapa

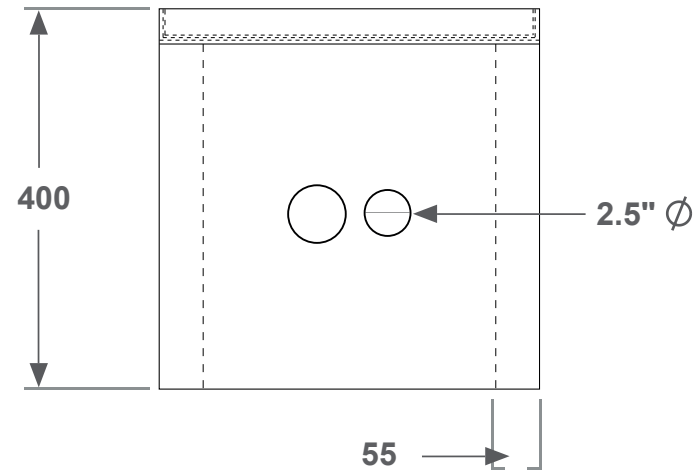
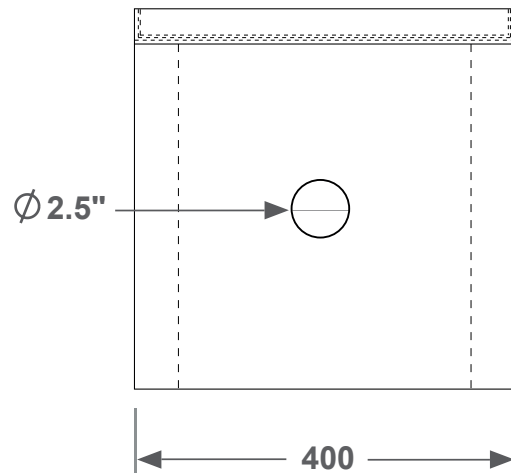
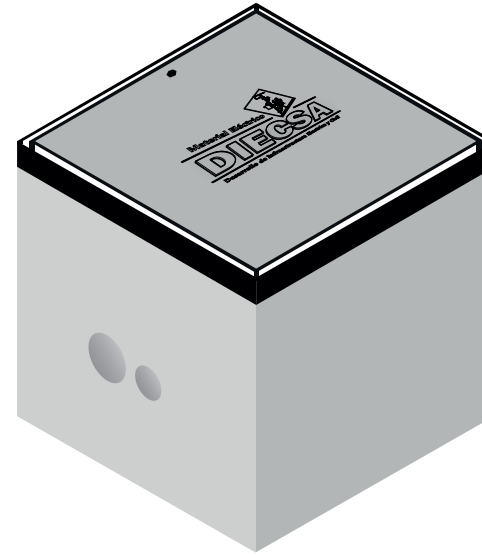
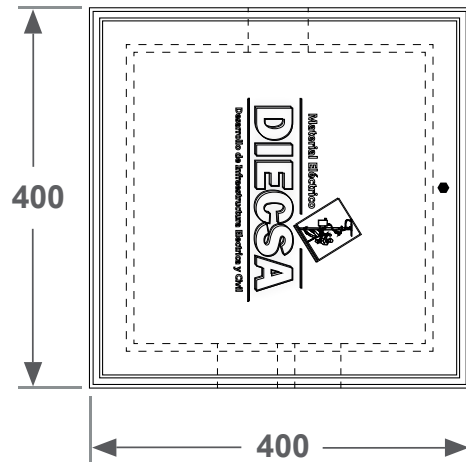

Dibuja:
Desarrollo de Infraestructura Eléctrica y Civil

Título:
DIEC- Registro C. 40 x 40 x 40

Materiales:
Concreto f'c= 200 kg/cm2

Acabado:
Pulido / Grabado

Peso Aproximado:
68 KG

Tolerancias:
 $\pm 5 \%$

Escala:
S/N

Formato:
A4

Cotas:
mm

Especificación:
Diec2010

Anotaciones: